



KK1000-FAST SWITCHING THYRISTOR

1800-2000 V_{DRM}

HIGH POWER THYRISTOR FOR INVERTER APPLICATION

Features:

- . All Diffused Structure
- . Amplifying Gate Configuration
- . Blocking capability up to 2000 volts
- . High dv/dt Capability
- . Pressure Assembled Device

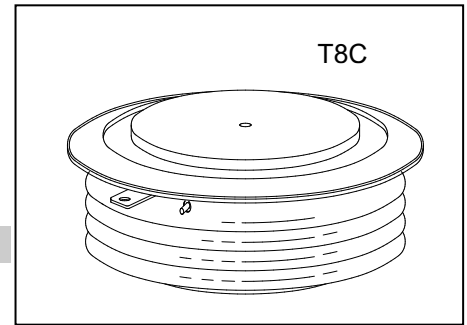

ELECTRICAL CHARACTERISTICS AND RATINGS

Blocking - Off State

Device Type	V_{RRM} (1)	V_{DRM} (1)	V_{RSM} (1)
KK1000/18	1800	1800	2000
KK1000/20	2000	2000	2100

V_{RRM} = Repetitive peak reverse voltage
 V_{DRM} = Repetitive peak off state voltage
 V_{RSM} = Non repetitive peak reverse voltage (2)

Repetitive peak reverse leakage and off state leakage	I_{RRM}/I_{DRM}	5 mA 80 mA (3)
Critical rate of voltage rise	dv/dt (4)	1000 V/ μ s

Notes:

All ratings are specified for $T_j=25^\circ\text{C}$ unless otherwise stated.

(1) All voltage ratings are specified for an applied 50Hz/60Hz sinusoidal waveform over the temperature range 0 to $+125^\circ\text{C}$

(2) 10 msec. Max. Pulse width

(3) Maximum value for $T_j=125^\circ\text{C}$.

(4) Minimum value for linear and exponential waveshape to 67% rated V_{DRM} . Gate open, $T_j=125^\circ\text{C}$

(5) The value of di/dt is established in accordance with JB/T4193-2013.

Conducting - On State

Parameter	Symbol	Min.	Max.	Typ.	Units	Conditions
Average value of on-state current	$I_{T(AV)}$		1000		A	Sinewave, 180° conduction, $T_c=55^\circ\text{C}$
RMS value of on-state current	$I_{T(RMS)}$		1570		A	Nominal value
Peak one cycle surge (non repetitive) current	I_{TSM}		14000		A	10 msec (50Hz), sinusoidal waveshape, 180° conduction, $T_j = 125^\circ\text{C}$
I square t	I^2t		9.8×10^5		A^2s	10 msec
Latching current	I_L		1000		mA	$V_D=12\text{V}$; $R_L=12\text{ohms}$
Holding current	I_H		200		mA	$V_D=12\text{V}$; $I=2.5\text{A}$
Peak on-state voltage	V_{TM}		2.40		V	$I_{TM}=3000\text{A}$; $T_j=25^\circ\text{C}$
Threshold voltage, low-level	V_{TO}		1.32		V	$T_j=125^\circ\text{C}$
Slope resistance, low-level	r_T		0.36		$\text{m}\Omega$	1500A to 2500A
Critical rate of rise of on-state current(5)	di/dt		200		A/ μ s	$T_j=125^\circ\text{C}$; $V_D = 0.67 V_{DRM}$; $f=50\text{Hz}$; $I_{TM}=1500\text{A}$

ELECTRICAL CHARACTERISTICS AND RATINGS KK1000-FAST SWITCHING THYRISTOR

Gating

Parameter	Symbol	Min.	Max.	Typ.	Units	Conditions
Peak gate power dissipation	P_{GM}		20		W	
Average gate power dissipation	$P_{G(AV)}$		4		W	
Gate-trigger current	I_{GT}		150		mA	$V_D=12V; R_L=3ohms; T_j=+25^{\circ}C$
Gate- trigger voltage	V_{GT}	0.70	2.5		V	$V_D=12V; R_L=3ohms; T_j=+25^{\circ}C$
Peak negative voltage	V_{GRM}		5		V	

Dynamic

Parameter	Symbol	Min.	Max.	Typ.	Units	Conditions
Delay time	t_d		3.0	2.5	μs	$I_{TM}=1000A; V_D=67\%V_{DRM}$ Gate pulse: $V_G=30V; R_G=10ohms;$ $t_r=0.1\mu s; t_p=20\mu s$
Turn-off time (with $V_R = -5 V$)	t_q		40		μs	$I_{TM} =1000 A; di/dt = - 10 A/\mu s;$ $V_R =50 V; dv/dt=30V/\mu s ;$ $V_D= 67\%V_{DRM}; T_j=125^{\circ}C$
Reverse recovery charge	Q_{rr}				μC	$I_{TM}=1000 A; di/dt=-10A/\mu s;$ $V_R=50 V; T_j=125^{\circ}C$

THERMAL AND MECHANICAL CHARACTERISTICS AND RATINGS

Parameter	Symbol	Min.	Max.	Typ.	Units	Conditions
Operating temperature	T_j	-40	+125		$^{\circ}C$	
Storage temperature	T_{stg}	-40	+140		$^{\circ}C$	
Thermal resistance - junction to case	$R_{\Theta(j-c)}$		0.022		$^{\circ}C/W$	Double sided cooled
Thermal resistance - case to heatsink	$R_{\Theta(c-s)}$		0.005		$^{\circ}C/W$	Double sided cooled
Mounting force	F	22	27	25	kN	
Weight	m			0.46	kg	

* Mounting surfaces smooth, flat and greased

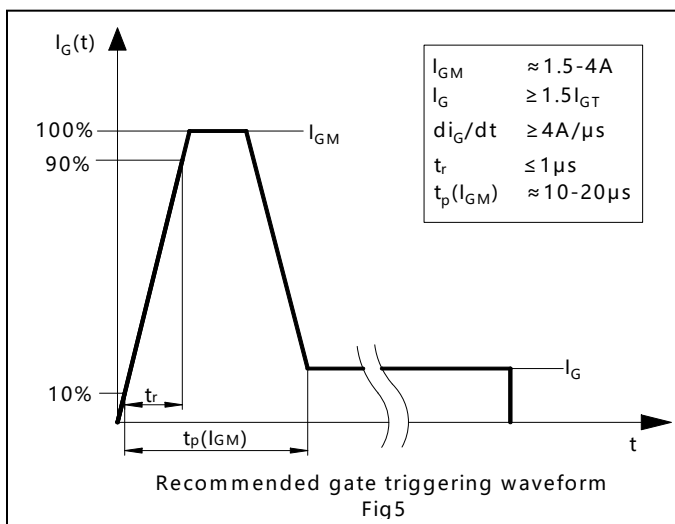
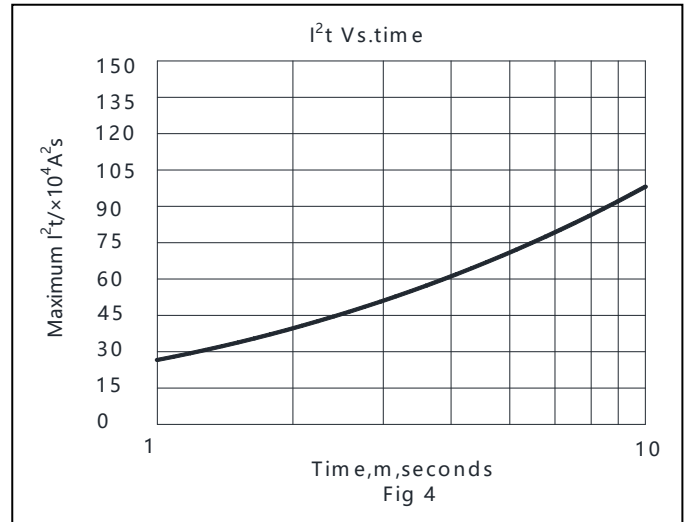
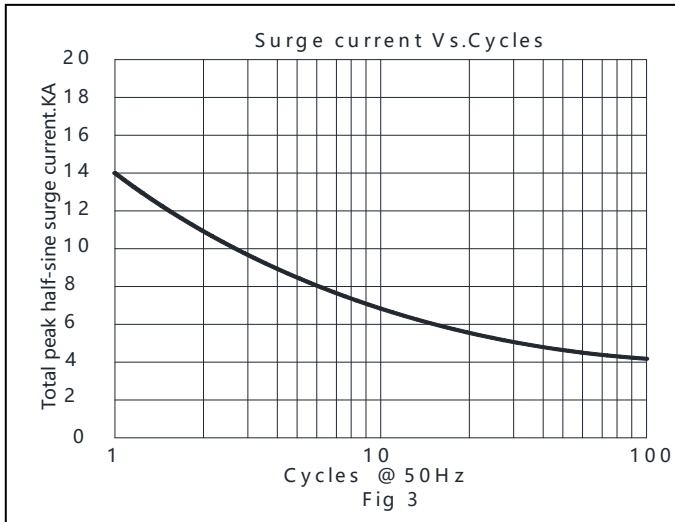
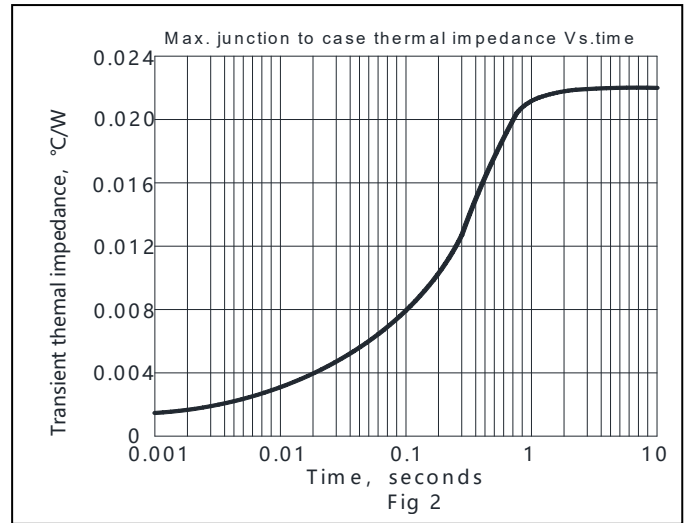
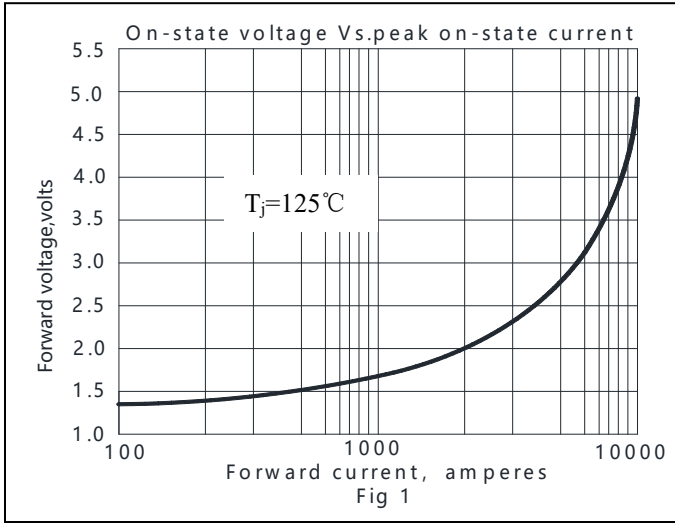

ELECTRICAL CHARACTERISTICS AND RATINGS KK1000-FAST SWITCHING THYRISTOR

